

1895 WEST DARTMOUTH AVENUE
DENVER, CO 80110

FASTENERS, INC
MECHANICAL AND CHEMICAL ANCHORING



PHONE: 303-777-7555
FAX: 303-781-9175

WEDGE ANCHOR
ROCK BOLT

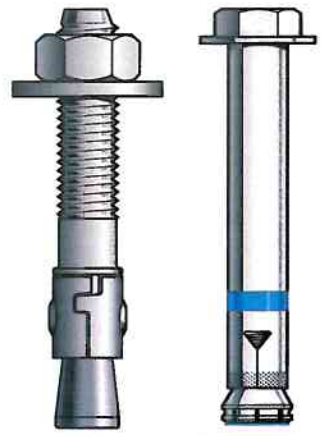

SLEEVE ANCHOR VARIATIONS

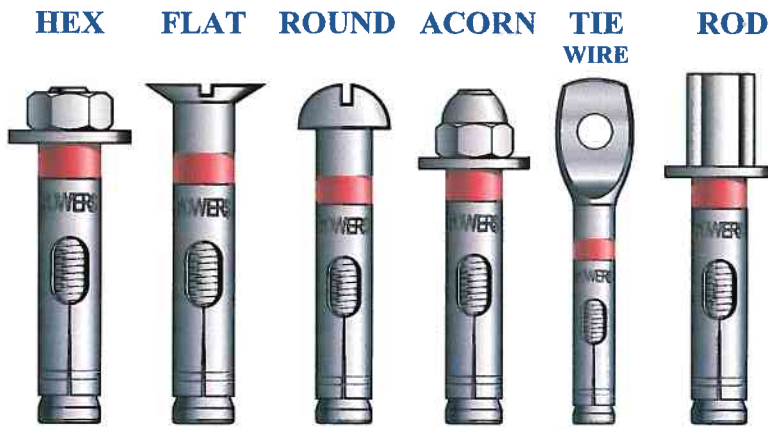

STUD ANCHOR
WEDGE-BOLT

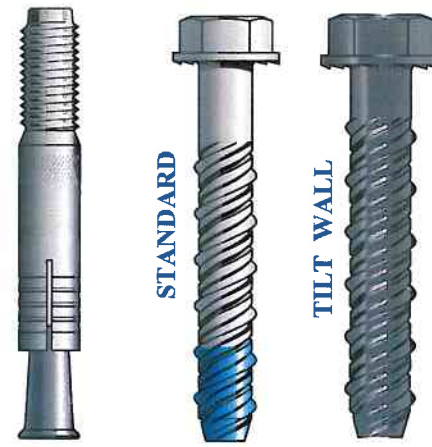

VERTIGO OVERHEAD ROD HANGERS
CONCRETE WOOD STEEL SELF DRILLING

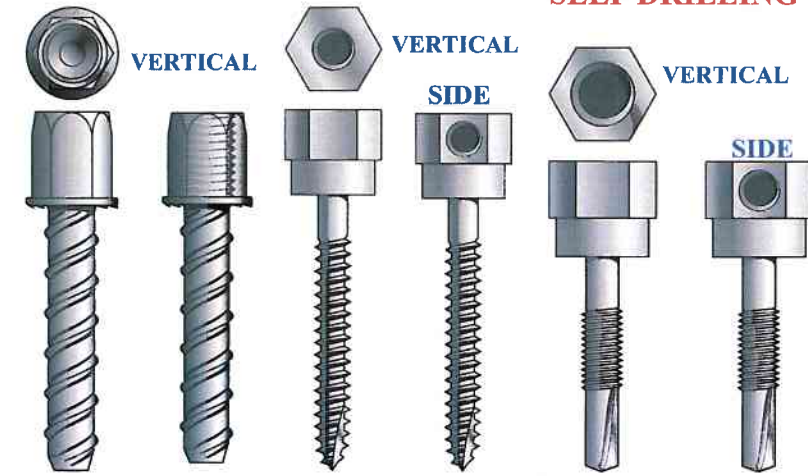

ZAMAC NAIL-IN SCREW IN MUSHROOM FLAT

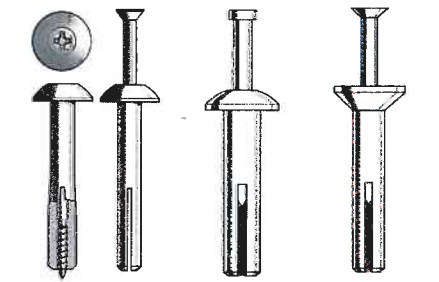

NYLON NAIL-IN MUSHROOM ROUND FLAT NO NAIL



DROP IN
HOLLOW DROP IN
MINI DROP IN
CAULK IN

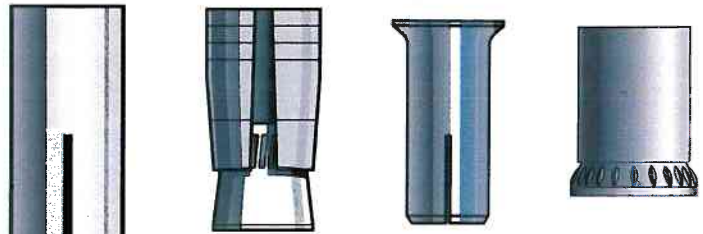

EXPANSION TYPE

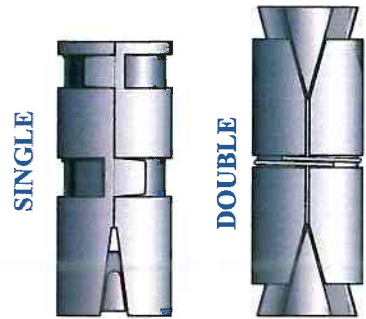

LAG SHIELD

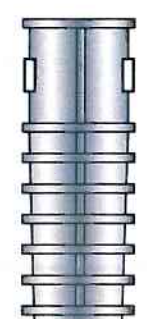

SPIKE HAMMER IN ANCHORS

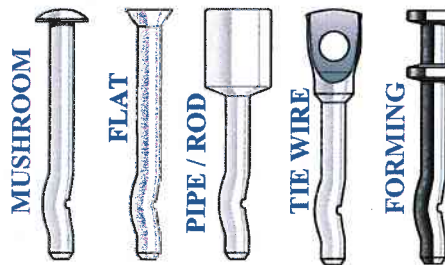

DRIVE ANCHORS

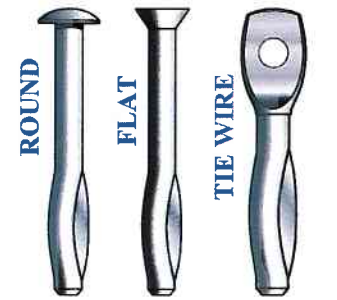

CONCRETE SCREWS (TAPCON)
STANDARD BLUE ZINC ALSO AVAILABLE ZINC, STAINLESS AND WHITE / LIMITED SIZES



PLUG TYPE ANCHORS



CARBIDE BIT SELECTION GUIDE

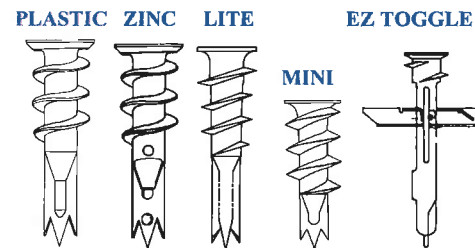
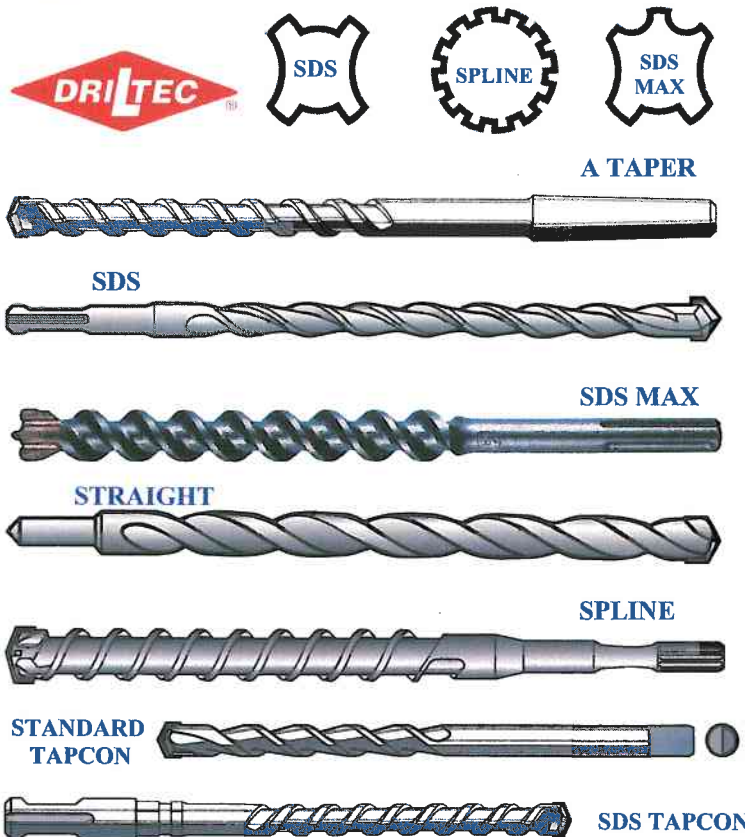

HOLLOW WALL / DRYWALL ANCHORING

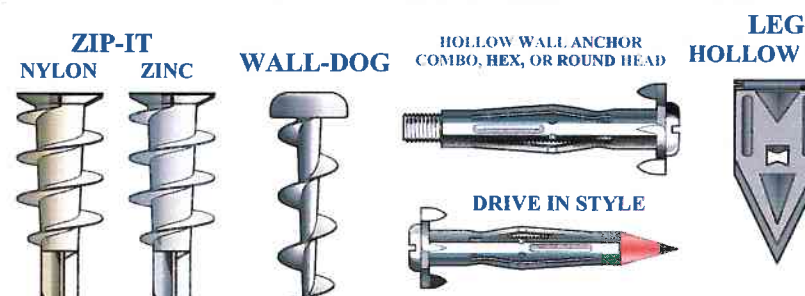

TOGGLE BOLT
AVAILABLE IN MUSHROOM HEAD FLAT, ROUND, AND HEX HEAD STYLES

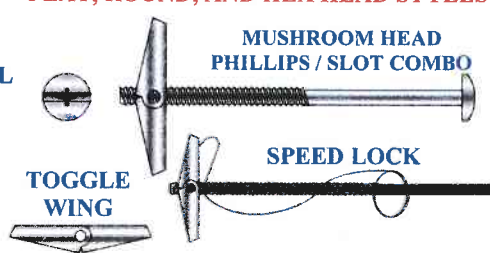

CHEMICAL ANCHORING SYSTEMS
AVAILABLE IN A VARIETY OF SETTING TIMES AND TUBE SIZES AND CONFIGURATIONS TO MEET THE NEEDS OF SMALL INSTALLATIONS AND LARGE COMPLEX PROJECTS



THIS PUBLICATION IS THE PROPERTY OF FASTENERS INC AND IS PROTECTED UNDER US COPYRIGHT LAWS. ANY REPRODUCTION IN PART OR WHOLE IS STRICTLY PROHIBITED.....